

Omni Wave Hollow Retroreflector - OWHR™

The Omni Wave Hollow Retroreflector (OWHR) can be described as a self-compensating mirror that is totally insensitive to position and movement such as tilt.

Parallel incident light that hits the OWHR will be returned with great accuracy to the light source, regardless of the OWHR's physical orientation. The OWHR is constructed of three first-surface mirrors assembled by a proprietary process into a mutually-orthogonal inside corner. This hollow configuration eliminates material absorption and chromatic aberration present in prism-type retroreflectors. The mirror coating can be optimized for various spectral ranges, from UV to far IR.

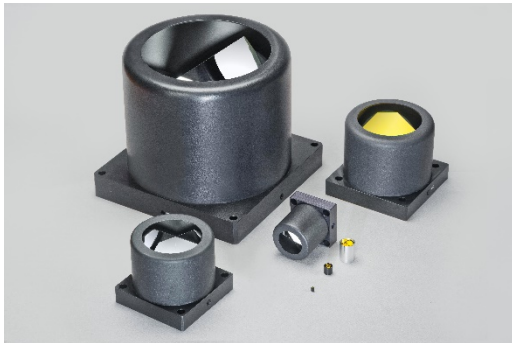

Specifications

| | |
|------------------|----------------------------------|
| Substrate | Pyrex |
| Housing material | Aluminum 6061 |
| Surface Flatness | $\lambda/10 - \lambda/20$ @633nm |
| Surface Quality | 80-50 Scratch-Dig |
| Beam Deviation | 0.5 – 30.0 Arcsecond |

Coating Types

- A – Enhanced Aluminum
- B – IR Enhanced Aluminum
- C – Unprotected Aluminum
- D – UV Enhanced Aluminum
- E – Protected Silver
- G – Protected Gold
- H – Unprotected gold
- I – Protected Aluminum

OWHRs are available in standard sizes of 0.08 in (2mm) to 5.0 in (125mm). The units are available in accuracies to 0.5 arc seconds beam deviation and $\lambda/10$ wave reflected wavefront error. In the new improved configuration, available only from PLX, the OWHR has a unique, patented, cushion mounting, which makes the unit extremely resistant to shock. The OWHR is provided in a versatile housing, which is compatible with all major mounting systems. The OWHR is available with a broad range of standard metallic coatings which meet all applicable MIL-specs. Unprotected metallic coatings are especially suited to interferometric applications. Custom coatings are available upon request.

Note:

Beam Deviation is the maximum deviation from parallelism, expressed in seconds of arc, of any single return beam from any of the 6 sub-apertures of the retroreflector, when the retroreflector is fully-illuminated.

Exiting Wavefront is the resultant maximum peak-to-valley wavefront deformation from a fully-illuminated retroreflector, where $\lambda = 633\text{nm}$. (See next page)

Beam deviation and exiting wavefront are interrelated, and it is only necessary to specify one.

Certain high accuracy models may be heavier than indicated here. Check with us for actual weight.

Important Notice

This datasheet contains typical information specific to products manufactured at the time of its publication. All rights reserved. All material herein is the property of PLX Inc. and shall not be reproduced without the written permission of PLX Inc.

Product Datasheet

Omni Wave Hollow Retroreflector - OWHR™



Outline Drawings

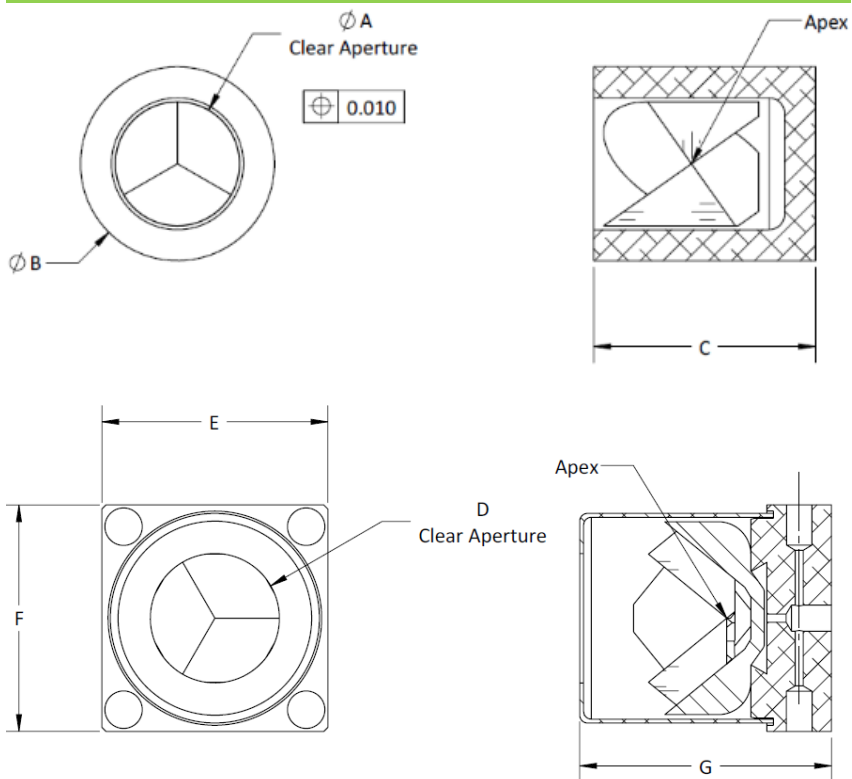

Specifications

| Item | Exiting Wavefront (p.v.633nm) | Weight (grams) |
|--------|-------------------------------|----------------|
| OW-008 | 0.35 | 0.06 |
| OW-016 | 0.55 | 0.07 |
| OW-025 | 0.60 | 0.80 |
| OW-05 | 0.30 – 0.90 | 5.9 |
| OW-10 | 0.15 – 3.50 | 108 |
| OW-15 | 0.10 – 5.25 | 330 |
| OW-20 | 0.15 – 7.00 | 454 |
| OW-25 | 0.25 – 9.00 | 772 |
| OW-50 | 0.45 – 18.0 | 3860 |

| Item | ØA (in/mm) | ØB (in/mm) | C (in/mm) |
|--------|------------|-------------|-------------|
| OW-008 | 0.08/2.03 | 0.13/3.18 | 0.14/3.63 |
| OW-016 | 0.16/4.06 | 0.21/5.33 | 0.20/5.08 |
| OW-025 | 0.25/6.35 | 0.32/8.13 | 0.32/8.13 |
| OW-05 | 0.5/12.7 | 0.58/14.61 | 0.75/19.05 |
| Item | ØD (in/mm) | E/F (in/mm) | G (in/mm) |
| OW-10 | 1.00/25.40 | 1.75/44.45 | 1.95/49.53 |
| OW-15 | 1.50/38.10 | 2.63/66.68 | 2.41/61.09 |
| OW-20 | 2.00/50.80 | 3.10/78.74 | 2.61/66.20 |
| OW-25 | 2.50/63.50 | 3.66/92.96 | 3.11/78.90 |
| OW-50 | 5.00/127 | 6.75/171.45 | 5.98/151.89 |

Coating Types

| SUFFIX | WAVELENGTH RANGE (nm) | AOI 55° PER-SURFACE REFLECTANCE (AVG) |
|--------|-----------------------|---------------------------------------|
| A | 400 - 700 | 93% |
| B | 600 - 1,600 | 89% |
| C | 225 - 10,000 | 90% |
| D | 225 - 700 | 89% |
| E | 450 - 10,000 | 96% |
| G | 650 - 16,000 | 97% |
| H | 650 - 20,000 | 97% |
| I | 400 - 750 | 87% |

Detailed coating curves are available in the following pages.

Product Datasheet

Omni Wave Hollow Retroreflector - OWHR™



Coating Curve

AOI 55°

A - Enhanced Aluminum Coating 400-700 nm

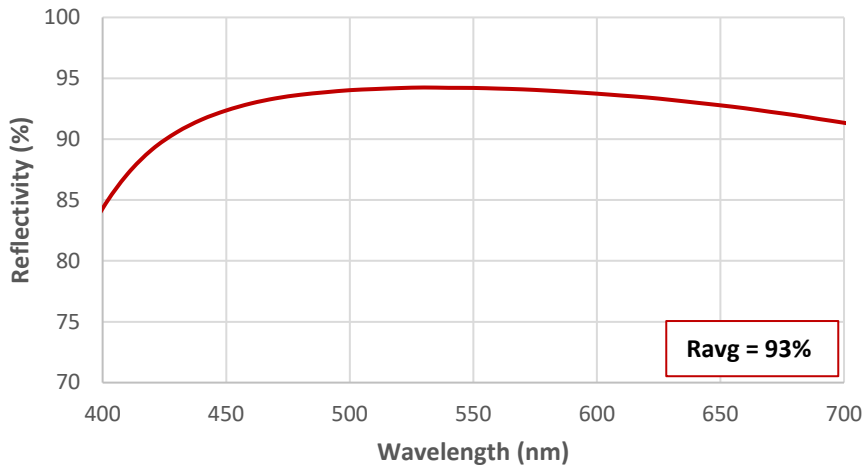

B - IR Enhanced Aluminum Coating 600-1600 nm

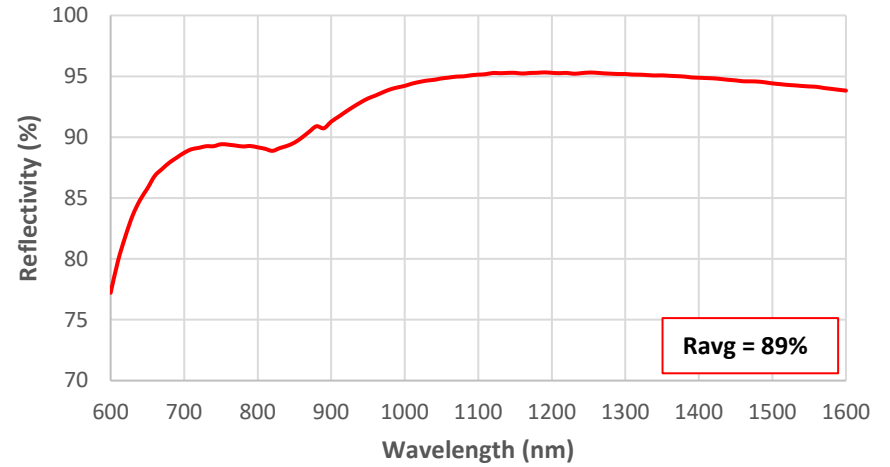

C - Unprotected Aluminum Coating 225-10000nm

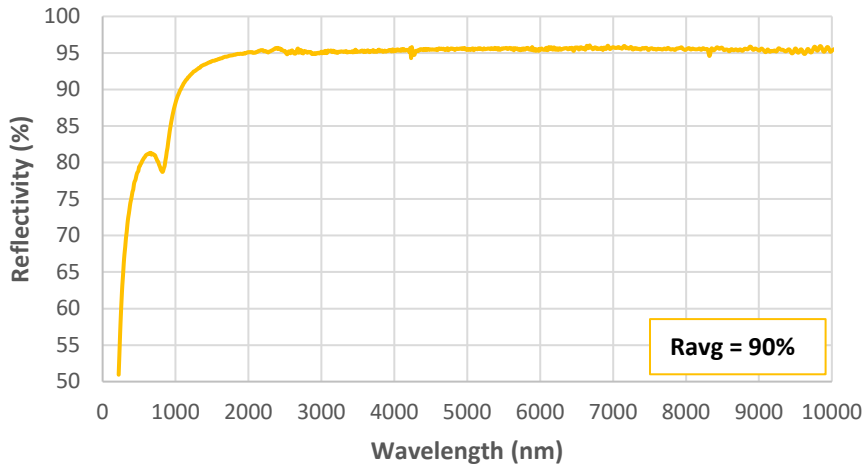

D - UV Enhanced Aluminum Coating 225-700 nm

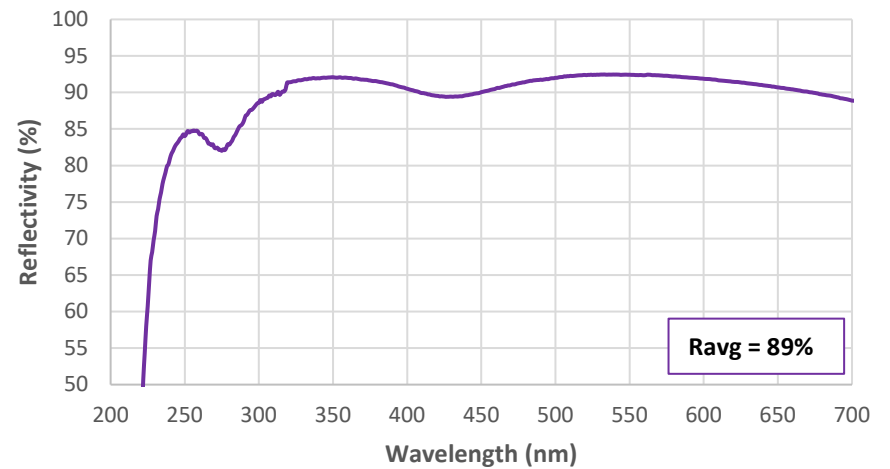

Note: Coatings meet Ravg requirement, but coating curves are for reference as $R(\lambda)$ may vary $\pm 2\%$ per

Coating Curve

AOI 55°

E - Protected Silver Coating 450-10000 nm

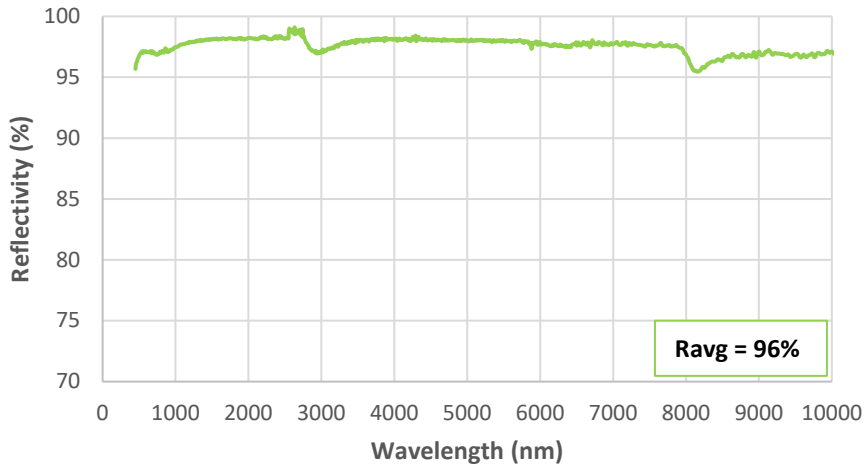

G - Protected Gold Coating 650-16000 nm

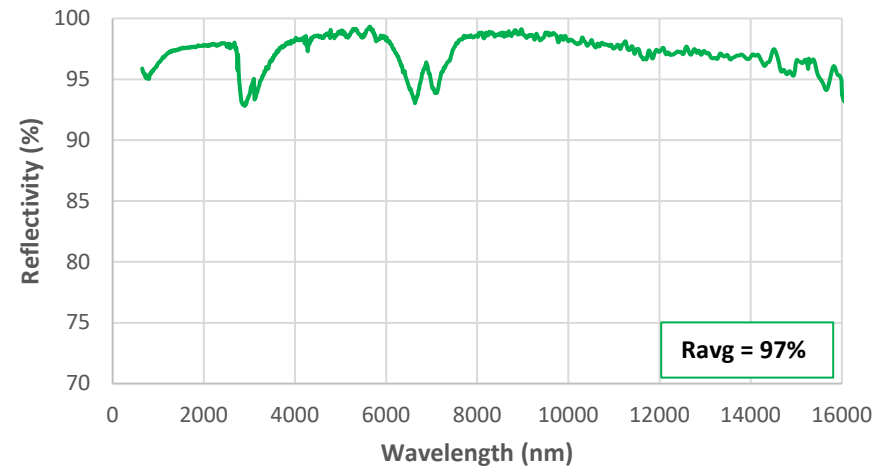

H - Unprotected Gold Coating 650-20000 nm

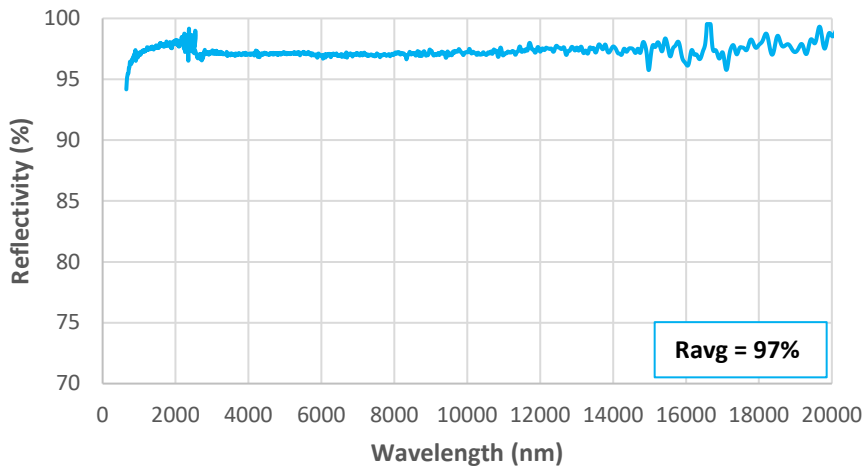

I - Protected Aluminum Coating 400-750 nm

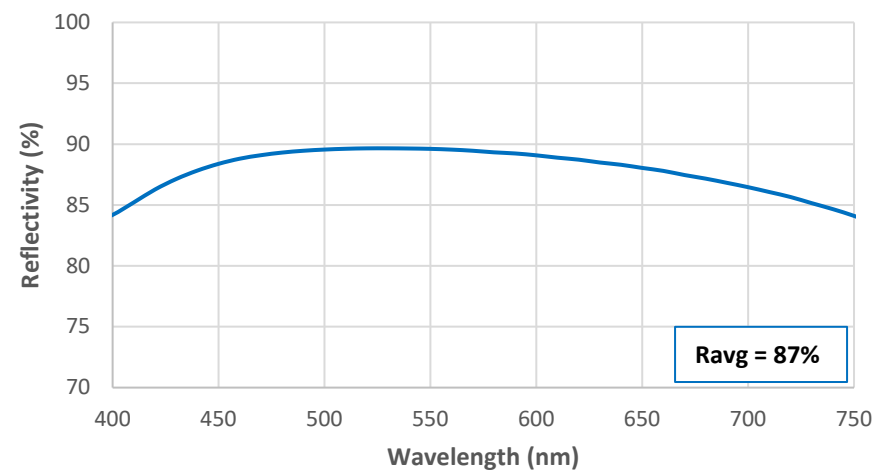

Note: Coatings meet Ravg requirement, but coating curves are for reference as R(λ) may vary ± 2% per